

## Fabricated sheet metal panels and components

We produce all fabricated parts in-house using our state-of-the-art manufacturing facilities which include CNC punching and break press folding machines. Flat sheet aluminium and steel can be punched with any number of holes or series of slots to produce special front panels, covers, tops and base panels for our enclosures. Fully bespoke enclosures and sheet metal parts can also be fabricated to your design using these processes. We work to your drawings and specifications.

**See below for a full stock list of sheet metal materials and standard hole punches we have available:**

### Options available:

- CNC punching of holes, slots, half shears, dimples, burst holes, vent louvres
- CNC folding of corners, tabs, flanges, dutch folds, joggles
- Fitting of inserts, PCB pillars, threaded studs, earth tags
- Linishing of aluminium panels for a blemish free finish.

**Contact our sales team for more information and a quotation.**

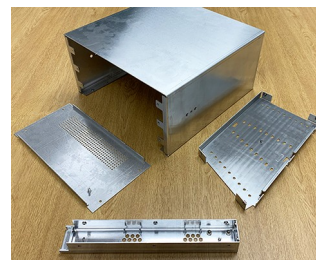
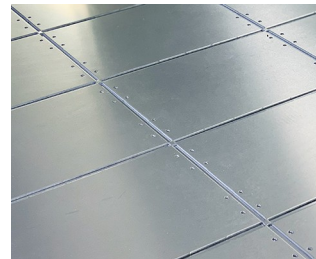
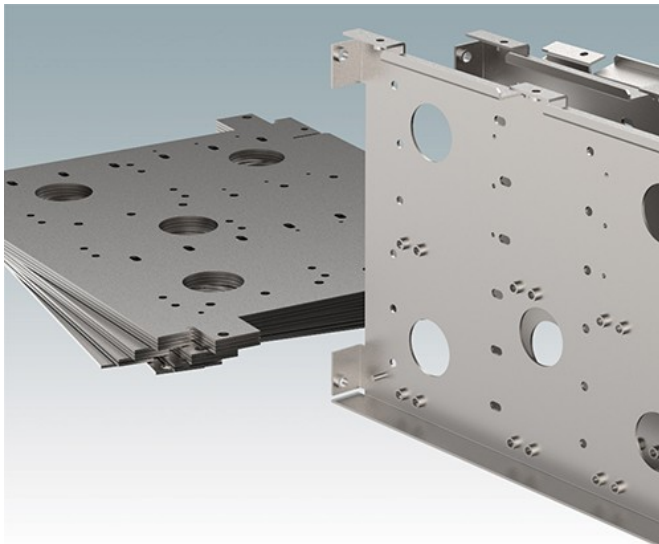

## Select Versions

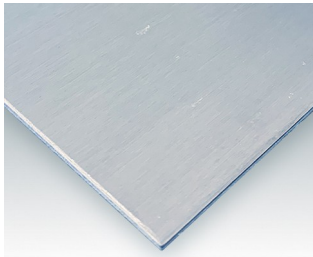

**M0000600**  
Aluminium Sheet  
Aluminium  
Natural finish



**M0000601**  
Aluminium Sheet  
Aluminium  
PVC protection film

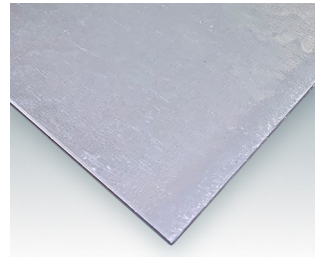

**M0000650**  
Mild Steel Sheet, Galvanised  
Mild Steel Galvanised  
Galvanised



**M0000651**  
Mild Steel Sheet, Galvanised  
Mild Steel Galvanised  
Galvanised



**M0000652**  
Mild Steel Sheet, Zintec  
Mild Steel Zintec  
Zinc coated

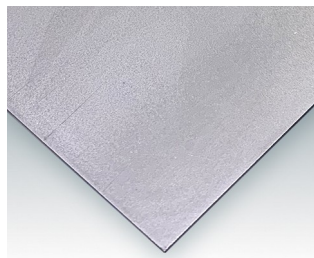

**M0000653**  
Mild Steel Sheet CR4  
Mild Steel CR4  
Natural finish

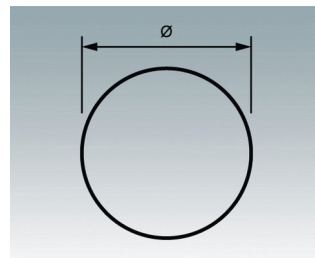

**M0000800**  
Round Cutout  
Punch Tools

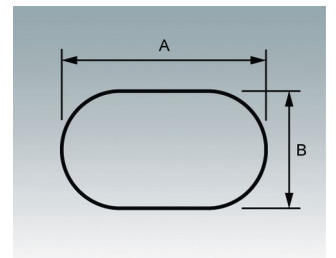

**M0000801**  
Obround Cutout  
Punch Tools

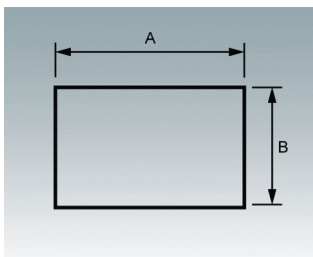

**M0000802**  
Rectangular Cutout  
Punch Tools

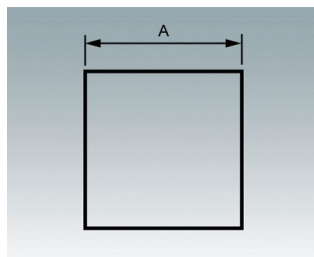

**M0000803**  
Square Cutout  
Punch Tools

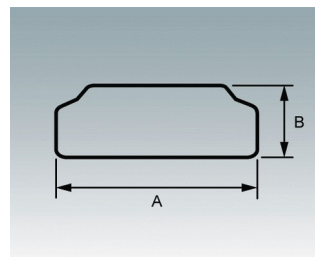

**M0000804**  
HDMI Cutout  
Punch Tools

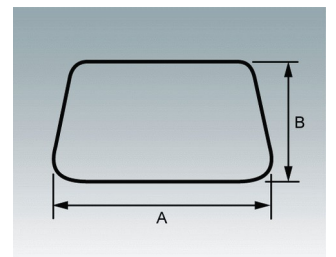

**M0000805**  
D-SUB Cutout  
Punch Tools

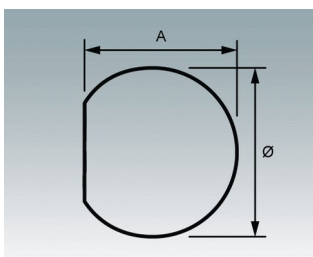

**M0000806**  
SD Cutout  
Punch Tools

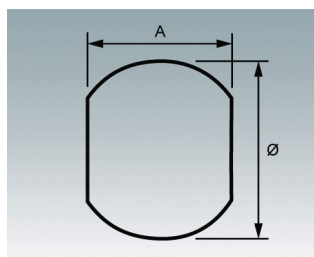

**M0000807**  
DD Cutout  
Punch Tools

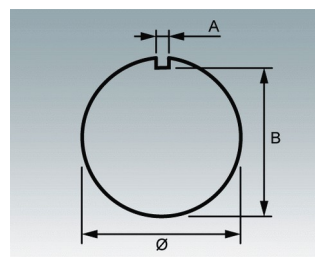

**M0000808**  
Keyway Cutout  
Punch Tools

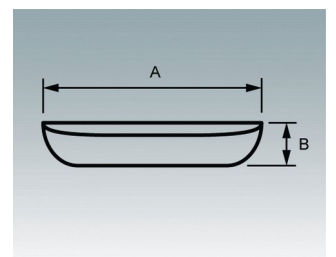

**M0000809**  
Ventilation Louvre  
Punch Tools

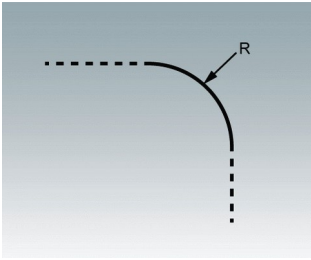

M0000810  
Corner Radius  
Punch Tools

Subject to technical modification without notice. © OKW Enclosures Ltd