

## Fabricated parts to your design

We can manufacture any fabricated sheet metalwork to your design specifications and drawings. We can work with sheet aluminium, steel and Zintec materials. Our state-of-the-art manufacturing site ensures the highest quality standards are maintained.

### Our facilities:

- CNC punching machines
- CNC break press folding machines
- CNC milling
- Drilling, tapping and sawing machines
- Automated inserting machines
- Linishing machines
- Full powder paint line
- Large wet paint cubicle
- A2 full colour CMYK digital printer.

**Contact our sales team for more information and a quotation.**

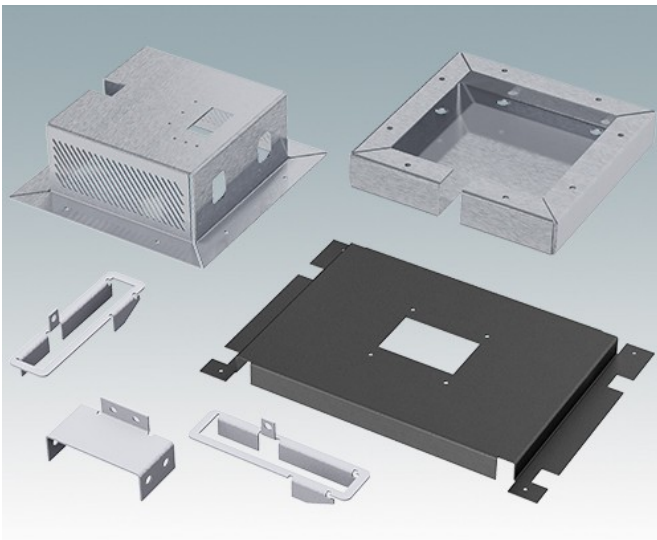

Subject to technical modification without notice. © OKW Enclosures Ltd